



Stainless Steel Cable Ties & Cabling Accessories



The Trustworthy  Products



a group  enterprise





GROUP CRYSTAL is a company involved in the manufacturing and exporting of cabling and wiring accessories. The parent company "**CRYSTAL EXPORTS**" is operational since 2004 and is catering to various international markets. Within a span of few years the company has grown several times in terms of turnover and manufacturing capacity. Backed up by hardcore professionals engaged in the field of cabling accessories for almost two decades will sail the company to azimuthal heights. The new mantra of the company is nothing but "**Application Engineering**". Any specific requirement of the customer is studied in detail and can offer perfect solutions which is backed up by a well established R & D team.

The Company boasts of an Inhouse Testing Facility which includes Tensile testing machine, Pull off load testing machine, micron testing machine to enable the best quality products to our customers.





CERTIFICATIONS



ISO 14001



ISO 9001



UL Certificate

Test Report No. GGNH(RO)/17/000898
Dated 2017-05-12

Applicant:
 Crystal Exports
 Crystal House, Building No. 4, Achind Blueberry Industrial Estate, Nalk
 Paga, Wani, Palghar (Maharashtra), 407328, India

Attention: Mr. Usar Galgot
Tested Sample: Received on 2017-05-02 4:18 pm
Test Period: 2017-05-08 to 2017-05-12
Sample: -SS316L Ball Lock type Cable Ties (Sample 1)

Test Sample Description:
 - ROPS Director 201 MBSU (bearing 200395EC) Annex II
 - Lamination used by valid amending directives
 - Cabling Accessories

Objectives of Examination:
 - Black
 - India
 - Not applicable
 - Not applicable
 - Steel Mechanical

Product Type / End use:
Colour:
Country of Origin:
Agency:
Agency Contact Person:
Name of Buyer / Distributor:

By accepting this document the customer hereby agrees and accepts the Terms & Conditions and the relevant Testing & Certification Regulations of TÜV SÜD South Asia Pvt. Ltd. which are available at Customer's website at www.tuv-sud.com and the relevant Indian Standards. The test report shall not be reproduced without the written approval of the laboratory.

Phone: 91 22 4479980
 Fax: 91 22 4479970
 E-mail: anuradha.dhamija@tuv-sud.in
 Web: www.tuv-sud.com
 TÜV SÜD South Asia Pvt. Ltd.
 372, 374, 376, 378, 380, 382, 384, 386, 388, 390, 392, 394, 396, 398, 400, 402, 404, 406, 408, 410, 412, 414, 416, 418, 420, 422, 424, 426, 428, 430, 432, 434, 436, 438, 440, 442, 444, 446, 448, 450, 452, 454, 456, 458, 460, 462, 464, 466, 468, 470, 472, 474, 476, 478, 480, 482, 484, 486, 488, 490, 492, 494, 496, 498, 500, 502, 504, 506, 508, 510, 512, 514, 516, 518, 520, 522, 524, 526, 528, 530, 532, 534, 536, 538, 540, 542, 544, 546, 548, 550, 552, 554, 556, 558, 560, 562, 564, 566, 568, 570, 572, 574, 576, 578, 580, 582, 584, 586, 588, 590, 592, 594, 596, 598, 600, 602, 604, 606, 608, 610, 612, 614, 616, 618, 620, 622, 624, 626, 628, 630, 632, 634, 636, 638, 640, 642, 644, 646, 648, 650, 652, 654, 656, 658, 660, 662, 664, 666, 668, 670, 672, 674, 676, 678, 680, 682, 684, 686, 688, 690, 692, 694, 696, 698, 700, 702, 704, 706, 708, 710, 712, 714, 716, 718, 720, 722, 724, 726, 728, 730, 732, 734, 736, 738, 740, 742, 744, 746, 748, 750, 752, 754, 756, 758, 760, 762, 764, 766, 768, 770, 772, 774, 776, 778, 780, 782, 784, 786, 788, 790, 792, 794, 796, 798, 800, 802, 804, 806, 808, 810, 812, 814, 816, 818, 820, 822, 824, 826, 828, 830, 832, 834, 836, 838, 840, 842, 844, 846, 848, 850, 852, 854, 856, 858, 860, 862, 864, 866, 868, 870, 872, 874, 876, 878, 880, 882, 884, 886, 888, 890, 892, 894, 896, 898, 900, 902, 904, 906, 908, 910, 912, 914, 916, 918, 920, 922, 924, 926, 928, 930, 932, 934, 936, 938, 940, 942, 944, 946, 948, 950, 952, 954, 956, 958, 960, 962, 964, 966, 968, 970, 972, 974, 976, 978, 980, 982, 984, 986, 988, 990, 992, 994, 996, 998, 1000

TÜV SÜD
 South Asia
 Chennai Extension
 K&K Centre

Test Report No. GGNH(RO)/17/000898
Dated 2017-05-12

Material List (As Identified by Laboratory)

Material No.	Component	Material	Color	Remark
A	SS316L Ball Lock type Cable Ties (Sample 1)	Stainless steel (substrate part)		Material confirmed by Applicant
B	Coating on SS316L Ball Lock type Cable Ties (Sample 1)	Coating		

Result Conclusion

Test	Composite Sampling (Material No.)	Conclusion	Remarks
FLAME RETARDANTS	B	PASS	
Heavy Metal	B	PASS	
Heavy Metal	A	PASS	
PHthalATES	B	PASS	

By accepting this document the customer hereby agrees and accepts the Terms & Conditions and the relevant Testing & Certification Regulations of TÜV SÜD South Asia Pvt. Ltd. which are available at Customer's website at www.tuv-sud.com and the relevant Indian Standards. The test report shall not be reproduced without the written approval of the laboratory.

Phone: 91 22 4479980
 Fax: 91 22 4479970
 E-mail: anuradha.dhamija@tuv-sud.in
 Web: www.tuv-sud.com
 TÜV SÜD South Asia Pvt. Ltd.
 372, 374, 376, 378, 380, 382, 384, 386, 388, 390, 392, 394, 396, 398, 400, 402, 404, 406, 408, 410, 412, 414, 416, 418, 420, 422, 424, 426, 428, 430, 432, 434, 436, 438, 440, 442, 444, 446, 448, 450, 452, 454, 456, 458, 460, 462, 464, 466, 468, 470, 472, 474, 476, 478, 480, 482, 484, 486, 488, 490, 492, 494, 496, 498, 500, 502, 504, 506, 508, 510, 512, 514, 516, 518, 520, 522, 524, 526, 528, 530, 532, 534, 536, 538, 540, 542, 544, 546, 548, 550, 552, 554, 556, 558, 560, 562, 564, 566, 568, 570, 572, 574, 576, 578, 580, 582, 584, 586, 588, 590, 592, 594, 596, 598, 600, 602, 604, 606, 608, 610, 612, 614, 616, 618, 620, 622, 624, 626, 628, 630, 632, 634, 636, 638, 640, 642, 644, 646, 648, 650, 652, 654, 656, 658, 660, 662, 664, 666, 668, 670, 672, 674, 676, 678, 680, 682, 684, 686, 688, 690, 692, 694, 696, 698, 700, 702, 704, 706, 708, 710, 712, 714, 716, 718, 720, 722, 724, 726, 728, 730, 732, 734, 736, 738, 740, 742, 744, 746, 748, 750, 752, 754, 756, 758, 760, 762, 764, 766, 768, 770, 772, 774, 776, 778, 780, 782, 784, 786, 788, 790, 792, 794, 796, 798, 800, 802, 804, 806, 808, 810, 812, 814, 816, 818, 820, 822, 824, 826, 828, 830, 832, 834, 836, 838, 840, 842, 844, 846, 848, 850, 852, 854, 856, 858, 860, 862, 864, 866, 868, 870, 872, 874, 876, 878, 880, 882, 884, 886, 888, 890, 892, 894, 896, 898, 900, 902, 904, 906, 908, 910, 912, 914, 916, 918, 920, 922, 924, 926, 928, 930, 932, 934, 936, 938, 940, 942, 944, 946, 948, 950, 952, 954, 956, 958, 960, 962, 964, 966, 968, 970, 972, 974, 976, 978, 980, 982, 984, 986, 988, 990, 992, 994, 996, 998, 1000

TÜV SÜD
 South Asia
 Chennai Extension
 K&K Centre

Test Report No. GGNH(M)/17/00907
Dated 2017.05.25

Applicant Name: Crystal Exports
Address: Crystal House, Building No. 4, Achind Blueberry Industrial Estate, Nalk Paga, Wani, Vetal (East), Palghar - 401208, Maharashtra (India)
Attention: Mr. Usar Galgot
Tested Sample: Received on 2017-05-06 at 4:01 p.m.
Test Period: 2017-05-08 to 2017-05-25
Sample Description: - SS 316L Ball Lock Type Cable Ties (Sample 1)
Colour: Black
Product Type / End Use: Cabling Accessories
Country of Origin: India
Objective of Examination: Halogen Test - BS EN 14582: 2016
Note: The submitted sample(s) have not drawn by the Laboratory

Remarks:
 1. Sample(s) is / are tested as on-received basis.
 2. Test(s) performed as requested by Applicant.
 3. The test(s) was submitted to TÜV SÜD Hong Kong.
 4. Conclusion of the test was drawn against compliance requirements(s) / Limit Max., as specified by Applicant.

Prepared By: *Anuradha Dhamija*
 Anuradha Dhamija
 Reviewer

Authorized By: *Souvik Bhattacharya*
 Souvik Bhattacharya
 Authorized Signatory

Please Contact: For any technical issues: Anuradha Dhamija at anuradha.dhamija@tuv-sud.in
 For any complaint: Krishna Devi at krishna.devi@tuv-sud.in

By accepting this document the customer hereby agrees and accepts the Terms & Conditions and the relevant Testing & Certification Regulations of TÜV SÜD South Asia Pvt. Ltd. which are available at Customer's website at www.tuv-sud.com and the relevant Indian Standards. The test report shall not be reproduced without the written approval of the laboratory.

Phone: 91 22 4479980
 Fax: 91 22 4479970
 E-mail: anuradha.dhamija@tuv-sud.in
 Web: www.tuv-sud.com
 TÜV SÜD South Asia Pvt. Ltd.
 372, 374, 376, 378, 380, 382, 384, 386, 388, 390, 392, 394, 396, 398, 400, 402, 404, 406, 408, 410, 412, 414, 416, 418, 420, 422, 424, 426, 428, 430, 432, 434, 436, 438, 440, 442, 444, 446, 448, 450, 452, 454, 456, 458, 460, 462, 464, 466, 468, 470, 472, 474, 476, 478, 480, 482, 484, 486, 488, 490, 492, 494, 496, 498, 500, 502, 504, 506, 508, 510, 512, 514, 516, 518, 520, 522, 524, 526, 528, 530, 532, 534, 536, 538, 540, 542, 544, 546, 548, 550, 552, 554, 556, 558, 560, 562, 564, 566, 568, 570, 572, 574, 576, 578, 580, 582, 584, 586, 588, 590, 592, 594, 596, 598, 600, 602, 604, 606, 608, 610, 612, 614, 616, 618, 620, 622, 624, 626, 628, 630, 632, 634, 636, 638, 640, 642, 644, 646, 648, 650, 652, 654, 656, 658, 660, 662, 664, 666, 668, 670, 672, 674, 676, 678, 680, 682, 684, 686, 688, 690, 692, 694, 696, 698, 700, 702, 704, 706, 708, 710, 712, 714, 716, 718, 720, 722, 724, 726, 728, 730, 732, 734, 736, 738, 740, 742, 744, 746, 748, 750, 752, 754, 756, 758, 760, 762, 764, 766, 768, 770, 772, 774, 776, 778, 780, 782, 784, 786, 788, 790, 792, 794, 796, 798, 800, 802, 804, 806, 808, 810, 812, 814, 816, 818, 820, 822, 824, 826, 828, 830, 832, 834, 836, 838, 840, 842, 844, 846, 848, 850, 852, 854, 856, 858, 860, 862, 864, 866, 868, 870, 872, 874, 876, 878, 880, 882, 884, 886, 888, 890, 892, 894, 896, 898, 900, 902, 904, 906, 908, 910, 912, 914, 916, 918, 920, 922, 924, 926, 928, 930, 932, 934, 936, 938, 940, 942, 944, 946, 948, 950, 952, 954, 956, 958, 960, 962, 964, 966, 968, 970, 972, 974, 976, 978, 980, 982, 984, 986, 988, 990, 992, 994, 996, 998, 1000

TÜV SÜD
 South Asia
 Chennai Extension
 K&K Centre



INDEX

■ CABLE TIES	
▶ ROLLER BALL LOCK TYPE CABLE TIES INTRODUCTION	01
▶ ROLLER BALL LOCK TYPE CABLE TIES UNCOATED	02
▶ ROLLER BALL LOCK TYPE CABLE TIES COATED	03
▶ RELEASABLE TYPE CABLE TIES UNCOATED	04
▶ RELEASABLE TYPE CABLE TIES PPA 571 COATED	05
▶ LADDER TYPE CABLE TIES UNCOATED	06
▶ LADDER TYPE CABLE TIES COATED	07
■ CABLE MARKER TAGS & CARRIER STRIPS	08
■ STRAPS	09
■ ALL PURPOSE BANDS	10
■ BUCKLES	11
■ TOOLS	12



ROLLER BALL LOCK TYPE CABLE TIES

INTRODUCTION

- ❖ Three Widths- 0.18" (4.6mm), 0.31"(7.9mm), 0.5"(12mm) for applications ranging from identification tagging to bundling large cables.
- ❖ Self Locking design allows fast installation
- ❖ Installation by hand or with tools to assure uniform tension & clean tail cut off for safe handling
- ❖ Available in SS 304 & SS 316L to provide good to excellent corrosion resistance in a wide variety of environments
- ❖ Available with or without non toxic, halogen free, Black Polyester coating

Self-Locking Application - Working Principle

- ❖ On the insertion of the stainless steel band into the buckle, the internal locking ball rolls freely.
- ❖ During tensioning, the band wedges into the buckle locking it tightly between the buckle and the band.

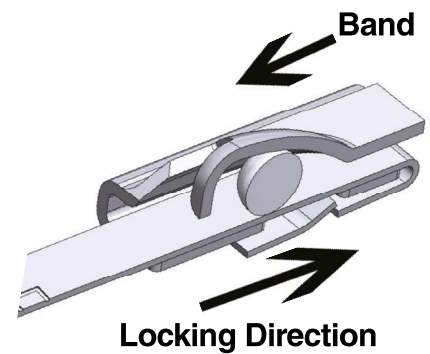

NOMENCLATURE

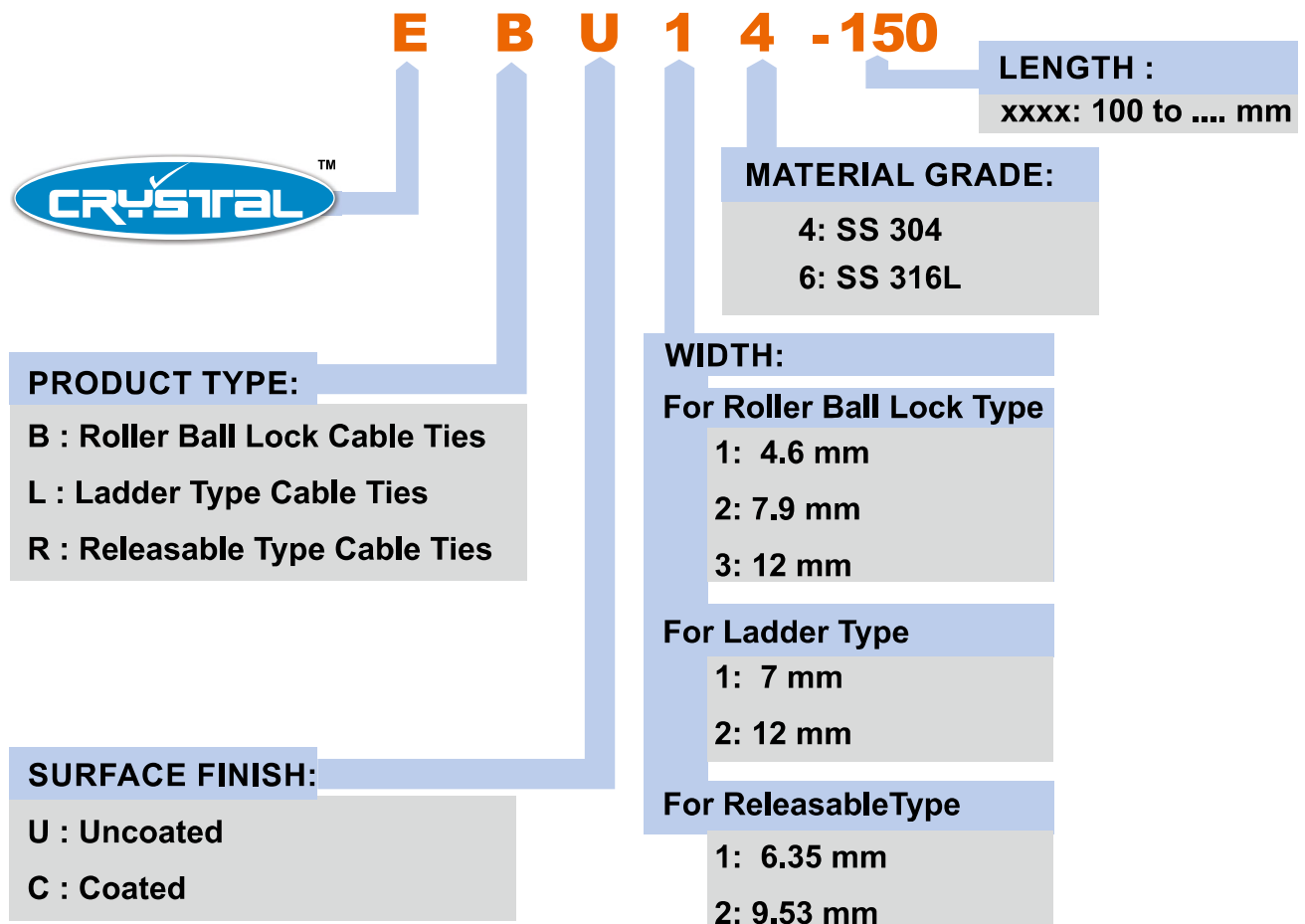



ROLLER BALL LOCK TYPE CABLE TIES

UNCOATED



Technical Specifications

Material : 304 and 316L grade non-magnetic stainless steel
Temperature Range : -60°C to +300°C
Surface Finish : Metallic
Flamability Rating : UL94 Fireproof & UV Resistant

Part Code as per Stainless Steel Grade		Width		Length		Thickness		Max. Loop Diameter		Max Loop Tensile Strength		Package Quantity
SS304	SS316L	Inch	mm	Inch	mm	Inch	mm	Inch	mm	N	lbs	Pcs
EBU14-100	EBU16-100	0.18	4.6	4	100	0.01	0.25	0.94	24	667	150	100/bag
EBU14-127	EBU16-127	0.18	4.6	5	127	0.01	0.25	1.02	26			
EBU14-150	EBU16-150	0.18	4.6	6	150	0.01	0.25	1.57	40			
EBU14-200	EBU16-200	0.18	4.6	8	200	0.01	0.25	2.20	56			
EBU14-260	EBU16-260	0.18	4.6	10	260	0.01	0.25	2.95	75			
EBU14-300	EBU16-300	0.18	4.6	12	300	0.01	0.25	3.46	88			
EBU14-360	EBU16-360	0.18	4.6	14	360	0.01	0.25	4.21	107			
EBU14-400	EBU16-400	0.18	4.6	16	400	0.01	0.25	4.53	115			
EBU14-450	EBU16-450	0.18	4.6	18	450	0.01	0.25	5.31	135			
EBU14-520	EBU16-520	0.18	4.6	20	520	0.01	0.25	6.22	158			
EBU14-550	EBU16-550	0.18	4.6	22	550	0.01	0.25	6.38	162			
EBU14-620	EBU16-620	0.18	4.6	24	620	0.01	0.25	7.48	190			
EBU14-680	EBU16-680	0.18	4.6	27	680	0.01	0.25	7.87	200			
EBU14-840	EBU16-840	0.18	4.6	33	840	0.01	0.25	10.24	260			
EBU14-1000	EBU16-1000	0.18	4.6	39	1000	0.01	0.25	12.24	311			

Part Code as per Stainless Steel Grade		Width		Length		Thickness		Max. Loop Diameter		Max Loop Tensile Strength		Package Quantity
SS304	SS316L	Inch	mm	Inch	mm	Inch	mm	Inch	mm	N	lbs	Pcs
EBU24-100	EBU26-100	0.31	7.9	4	100	0.01	0.25	0.94	24	1335	300	100/bag
EBU24-127	EBU26-127	0.31	7.9	5	127	0.01	0.25	1.02	26			
EBU24-150	EBU26-150	0.31	7.9	6	150	0.01	0.25	1.57	40			
EBU24-200	EBU26-200	0.31	7.9	8	200	0.01	0.25	2.20	56			
EBU24-260	EBU26-260	0.31	7.9	10	260	0.01	0.25	2.95	75			
EBU24-300	EBU26-300	0.31	7.9	12	300	0.01	0.25	3.46	88			
EBU24-360	EBU26-360	0.31	7.9	14	360	0.01	0.25	4.21	107			
EBU24-400	EBU26-400	0.31	7.9	16	400	0.01	0.25	4.53	115			
EBU24-450	EBU26-450	0.31	7.9	18	450	0.01	0.25	5.31	135			
EBU24-520	EBU26-520	0.31	7.9	20	520	0.01	0.25	6.22	158			
EBU24-550	EBU26-550	0.31	7.9	22	550	0.01	0.25	6.38	162			
EBU24-620	EBU26-620	0.31	7.9	24	620	0.01	0.25	7.48	190			
EBU24-680	EBU26-680	0.31	7.9	27	680	0.01	0.25	7.87	200			
EBU24-840	EBU26-840	0.31	7.9	33	840	0.01	0.25	10.24	260			
EBU24-1000	EBU26-1000	0.31	7.9	39	1000	0.01	0.25	12.24	311			

Part Code as per Stainless Steel Grade		Width		Length		Thickness		Max. Loop Diameter		Max Loop Tensile Strength		Package Quantity
SS304	SS316L	Inch	mm	Inch	mm	Inch	mm	Inch	mm	N	lbs	Pcs
EBU34-100	EBU36-100	0.5	12	4	100	0.01	0.3	0.94	24	2000	450	100/bag
EBU34-127	EBU36-127	0.5	12	5	127	0.01	0.3	1.02	26			
EBU34-150	EBU36-150	0.5	12	6	150	0.01	0.3	1.57	40			
EBU34-200	EBU36-200	0.5	12	8	200	0.01	0.3	2.20	56			
EBU34-260	EBU36-260	0.5	12	10	260	0.01	0.3	2.95	75			
EBU34-300	EBU36-300	0.5	12	12	300	0.01	0.3	3.46	88			
EBU34-360	EBU36-360	0.5	12	14	360	0.01	0.3	4.21	107			
EBU34-400	EBU36-400	0.5	12	16	400	0.01	0.3	4.53	115			
EBU34-450	EBU36-450	0.5	12	18	450	0.01	0.3	5.31	135			
EBU34-520	EBU36-520	0.5	12	20	520	0.01	0.3	6.22	158			
EBU34-550	EBU36-550	0.5	12	22	550	0.01	0.3	6.38	162			
EBU34-620	EBU36-620	0.5	12	24	620	0.01	0.3	7.48	190			
EBU34-680	EBU36-680	0.5	12	27	680	0.01	0.3	7.87	200			
EBU34-840	EBU36-840	0.5	12	33	840	0.01	0.3	10.24	260			
EBU34-1000	EBU36-1000	0.5	12	39	1000	0.01	0.3	12.24	311			



ROLLER BALL LOCK TYPE CABLE TIES
COATED



Technical Specifications

- Material** : 304 and 316L grade non-magnetic stainless steel
- Temperature Range** : -60°C to +150°C
- Surface Finish** : Epoxy / Polyester Coated
- Flamability Rating** : UL94 Fireproof & UV Resistant

Part Code as per Stainless Steel Grade		Width		Length		Thickness		Max. Loop Diameter		Max Loop Tensile Strength		Package Quantity
SS304	SS316L	Inch	mm	Inch	mm	Inch	mm	Inch	mm	N	lbs	Pcs
EBC14-100	EBC16-100	0.18	4.6	4	100	0.01	0.25	0.94	24	465	105	100/bag
EBC14-127	EBC16-127	0.18	4.6	5	127	0.01	0.25	1.02	26			
EBC14-150	EBC16-150	0.18	4.6	6	150	0.01	0.25	1.57	40			
EBC14-200	EBC16-200	0.18	4.6	8	200	0.01	0.25	2.20	56			
EBC14-260	EBC16-260	0.18	4.6	10	260	0.01	0.25	2.95	75			
EBC14-300	EBC16-300	0.18	4.6	12	300	0.01	0.25	3.46	88			
EBC14-360	EBC16-360	0.18	4.6	14	360	0.01	0.25	4.21	107			
EBC14-400	EBC16-400	0.18	4.6	16	400	0.01	0.25	4.53	115			
EBC14-450	EBC16-450	0.18	4.6	18	450	0.01	0.25	5.31	135			
EBC14-520	EBC16-520	0.18	4.6	20	520	0.01	0.25	6.22	158			
EBC14-550	EBC16-550	0.18	4.6	22	550	0.01	0.25	6.38	162			
EBC14-620	EBC16-620	0.18	4.6	24	620	0.01	0.25	7.48	190			
EBC14-680	EBC16-680	0.18	4.6	27	680	0.01	0.25	7.87	200			
EBC14-840	EBC16-840	0.18	4.6	33	840	0.01	0.25	10.24	260			
EBC14-1000	EBC16-1000	0.18	4.6	39	1000	0.01	0.25	12.24	311			

Part Code as per Stainless Steel Grade		Width		Length		Thickness		Max. Loop Diameter		Max Loop Tensile Strength		Package Quantity
SS304	SS316L	Inch	mm	Inch	mm	Inch	mm	Inch	mm	N	lbs	Pcs
EBC24-150	EBC26-150	0.31	7.9	6	150	0.01	0.25	1.57	40	1200	270	100/bag
EBC24-200	EBC26-200	0.31	7.9	8	200	0.01	0.25	2.20	56			
EBC24-260	EBC26-260	0.31	7.9	10	260	0.01	0.25	2.95	75			
EBC24-300	EBC26-300	0.31	7.9	12	300	0.01	0.25	3.46	88			
EBC24-360	EBC26-360	0.31	7.9	14	360	0.01	0.25	4.21	107			
EBC24-400	EBC26-400	0.31	7.9	16	400	0.01	0.25	4.53	115			
EBC24-450	EBC26-450	0.31	7.9	18	450	0.01	0.25	5.31	135			
EBC24-520	EBC26-520	0.31	7.9	20	520	0.01	0.25	6.22	158			
EBC24-550	EBC26-550	0.31	7.9	22	550	0.01	0.25	6.38	162			
EBC24-620	EBC26-620	0.31	7.9	24	620	0.01	0.25	7.48	190			
EBC24-680	EBC26-680	0.31	7.9	27	680	0.01	0.25	7.87	200			
EBC24-840	EBC26-840	0.31	7.9	33	840	0.01	0.25	10.24	260			
EBC24-1000	EBC26-1000	0.31	7.9	39	1000	0.01	0.25	12.24	311			

Part Code as per Stainless Steel Grade		Width		Length		Thickness		Max. Loop Diameter		Max Loop Tensile Strength		Package Quantity
SS304	SS316L	Inch	mm	Inch	mm	Inch	mm	Inch	mm	N	lbs	Pcs
EBC34-200	EBC36-200	0.5	12	8	200	0.01	0.3	2.20	56	2000	450	100/bag
EBC34-260	EBC36-260	0.5	12	10	260	0.01	0.3	2.95	75			
EBC34-300	EBC36-300	0.5	12	12	300	0.01	0.3	3.46	88			
EBC34-360	EBC36-360	0.5	12	14	360	0.01	0.3	4.21	107			
EBC34-400	EBC36-400	0.5	12	16	400	0.01	0.3	4.53	115			
EBC34-450	EBC36-450	0.5	12	18	450	0.01	0.3	5.31	135			
EBC34-520	EBC36-520	0.5	12	20	520	0.01	0.3	6.22	158			
EBC34-550	EBC36-550	0.5	12	22	550	0.01	0.3	6.38	162			
EBC34-620	EBC36-620	0.5	12	24	620	0.01	0.3	7.48	190			
EBC34-680	EBC36-680	0.5	12	27	680	0.01	0.3	7.87	200			
EBC34-840	EBC36-840	0.5	12	33	840	0.01	0.3	10.24	260			
EBC34-1000	EBC36-1000	0.5	12	39	1000	0.01	0.3	12.24	311			

❖ Also available in multicolor options.



RELEASABLE TYPE CABLE TIES

UNCOATED

Technical Specifications

- Material** : 304 and 316L grade non-magnetic stainless steel
- Temperature Range** : -60°C to +300°C
- Surface Finish** : Metallic
- Flamability Rating** : UL94 Fireproof & UV Resistant

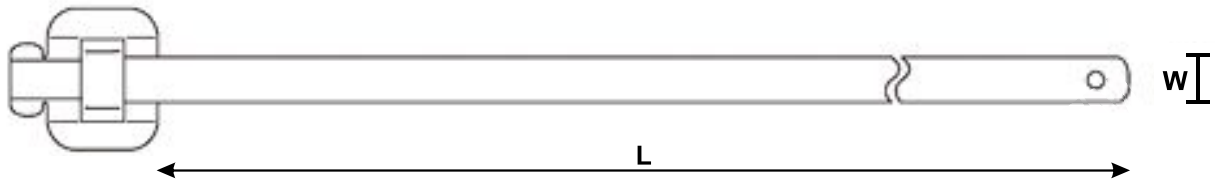

Part Code as per Stainless Steel Grade		Width		Length		Thickness		Max. Loop Diameter		Max Loop Tensile Strength		Package Quantity
SS304	SS316L	Inch	mm	Inch	mm	Inch	mm	Inch	mm	N	lbs	Pcs
ERU14-152	ERU16-152	1/4	6.35	6	152	0.015	0.40	1.5	38	1335	300	100/bag
ERU14-229	ERU16-229	1/4	6.35	9	229	0.015	0.40	2.5	63			
ERU14-305	ERU16-305	1/4	6.35	12	305	0.015	0.40	3.4	86			
ERU14-330	ERU16-330	1/4	6.35	13	330	0.015	0.40	3.7	95			
ERU14-457	ERU16-457	1/4	6.35	18	457	0.015	0.40	5.4	137			
ERU14-610	ERU16-610	1/4	6.35	24	610	0.015	0.40	7.3	185			
ERU14-762	ERU16-762	1/4	6.35	30	762	0.015	0.40	9.1	231			
ERU14-914	ERU16-914	1/4	6.35	36	914	0.015	0.40	11.0	280			
ERU14-1000	ERU16-1000	1/4	6.35	39	1000	0.015	0.40	11.8	300			
ERU14-1400	ERU16-1400	1/4	6.35	55	1400	0.015	0.40	16.9	430			

Part Code as per Stainless Steel Grade		Width		Length		Thickness		Max. Loop Diameter		Max Loop Tensile Strength		Package Quantity
SS304	SS316L	Inch	mm	Inch	mm	Inch	mm	Inch	mm	N	lbs	Pcs
ERU24-152	ERU26-152	3/8	9.53	6	152	0.015	0.40	1.5	38	1800	405	100/bag
ERU24-229	ERU26-229	3/8	9.53	9	229	0.015	0.40	2.5	63			
ERU24-305	ERU26-305	3/8	9.53	12	305	0.015	0.40	3.4	86			
ERU24-330	ERU26-330	3/8	9.53	13	330	0.015	0.40	3.7	95			
ERU24-457	ERU26-457	3/8	9.53	18	457	0.015	0.40	5.4	137			
ERU24-610	ERU26-610	3/8	9.53	24	610	0.015	0.40	7.3	185			
ERU24-762	ERU26-762	3/8	9.53	30	762	0.015	0.40	9.1	231			
ERU24-914	ERU26-914	3/8	9.53	36	914	0.015	0.40	11.0	280			
ERU24-1000	ERU26-1000	3/8	9.53	39	1000	0.015	0.40	11.8	300			
ERU24-1400	ERU26-1400	3/8	9.53	55	1400	0.015	0.40	16.9	430			

INSTALLATION METHOD

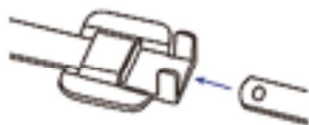

Insert the tail into the buckle.



Thread the tie through buckle, then tighten the bundle with crimping tool. Fold over the remaining tail of tie and secure by hammering down the ears of the buckle. The remaining tie may be cut to finish the processes.



RELEASABLE TYPE CABLE TIES

PPA 571 COATED



Technical Specifications

Material	:	304 and 316L grade non-magnetic stainless steel
Temperature Range	:	-60°C to +90°C
Surface Finish	:	PPA 571 Black Coating
Flamability Rating	:	UL94 Fireproof & UV Resistant

Part Code as per Stainless Steel Grade		Width		Length		Thickness		Max. Loop Diameter		Max Loop Tensile Strength		Package Quantity
SS304	SS316L	Inch	mm	Inch	mm	Inch	mm	Inch	mm	N	lbs	Pcs
ERC14-152	ERC16-152	1/4	6.35	6	152	0.015	0.40	1.5	38	1335	300	100/bag
ERC14-229	ERC16-229	1/4	6.35	9	229	0.015	0.40	2.5	63			
ERC14-305	ERC16-305	1/4	6.35	12	305	0.015	0.40	3.4	86			
ERC14-330	ERC16-330	1/4	6.35	13	330	0.015	0.40	3.7	95			
ERC14-457	ERC16-457	1/4	6.35	18	457	0.015	0.40	5.4	137			
ERC14-610	ERC16-610	1/4	6.35	24	610	0.015	0.40	7.3	185			
ERC14-762	ERC16-762	1/4	6.35	30	762	0.015	0.40	9.1	231			
ERC14-914	ERC16-914	1/4	6.35	36	914	0.015	0.40	11.0	280			
ERC14-1000	ERC16-1000	1/4	6.35	39	1000	0.015	0.40	11.8	300			
ERC14-1400	ERC16-1400	1/4	6.35	55	1400	0.015	0.40	16.9	430			

Part Code as per Stainless Steel Grade		Width		Length		Thickness		Max. Loop Diameter		Max Loop Tensile Strength		Package Quantity
SS304	SS316L	Inch	mm	Inch	mm	Inch	mm	Inch	mm	N	lbs	Pcs
ERC24-152	ERC26-152	3/8	9.53	6	152	0.015	0.40	1.5	38	1800	405	100/bag
ERC24-229	ERC26-229	3/8	9.53	9	229	0.015	0.40	2.5	63			
ERC24-305	ERC26-305	3/8	9.53	12	305	0.015	0.40	3.4	86			
ERC24-330	ERC26-330	3/8	9.53	13	330	0.015	0.40	3.7	95			
ERC24-457	ERC26-457	3/8	9.53	18	457	0.015	0.40	5.4	137			
ERC24-610	ERC26-610	3/8	9.53	24	610	0.015	0.40	7.3	185			
ERC24-762	ERC26-762	3/8	9.53	30	762	0.015	0.40	9.1	231			
ERC24-914	ERC26-914	3/8	9.53	36	914	0.015	0.40	11.0	280			
ERC24-1000	ERC26-1000	3/8	9.53	39	1000	0.015	0.40	11.8	300			
ERC24-1400	ERC26-1400	3/8	9.53	55	1400	0.015	0.40	16.9	430			

SALIENT FEATURES OF PPA 571 COATING

- ❖ PPA 571 is a flexible, tough and highly durable plastic coating.
- ❖ Superior resistance to Sun, Salt and Sea Water.
- ❖ Low temperature performance upto -60° C.
- ❖ Environment friendly, maintenance free, glossy attractive coating.
- ❖ Free of Bisphenol A (BPA), PVC, Halogens, Phthalates and Heavy metals.
- ❖ Smooth rounded edges.
- ❖ Flame retardant and Non-toxic.
- ❖ Water Absorption Free.



LADDER TYPE CABLE TIES

UNCOATED



Technical Specifications

Material : 304 and 316L grade non-magnetic stainless steel
Temperature Range : -60°C to +300°C
Surface Finish : Metallic
Flamability Rating : UL94 Fireproof & UV Resistant

Part Code as per Stainless Steel Grade		Width		Length		Thickness		Max. Loop Diameter		Max Loop Tensile Strength		Package Quantity
SS304	SS316L	Inch	mm	Inch	mm	Inch	mm	Inch	mm	N	lbs	Pcs
ELU14-100	ELU16-100	0.28	7	4	100	0.012	0.3	0.94	24	400	90	100/bag
ELU14-150	ELU16-150	0.28	7	6	150	0.012	0.3	1.89	48			
ELU14-200	ELU16-200	0.28	7	8	200	0.012	0.3	2.52	64			
ELU14-225	ELU16-225	0.28	7	9	225	0.012	0.3	2.83	72			
ELU14-250	ELU16-250	0.28	7	10	250	0.012	0.3	3.15	80			
ELU14-300	ELU16-300	0.28	7	12	300	0.012	0.3	3.78	96			
ELU14-350	ELU16-350	0.28	7	14	350	0.012	0.3	4.33	110			
ELU14-360	ELU16-360	0.28	7	14	360	0.012	0.3	4.53	115			
ELU14-400	ELU16-400	0.28	7	16	400	0.012	0.3	5.28	134			
ELU14-450	ELU16-450	0.28	7	18	450	0.012	0.3	5.63	143			
ELU14-500	ELU16-500	0.28	7	20	500	0.012	0.3	6.54	166			
ELU14-550	ELU16-550	0.28	7	22	550	0.012	0.3	7.13	181			
ELU14-610	ELU16-610	0.28	7	24	610	0.012	0.3	7.64	194			
ELU14-750	ELU16-750	0.28	7	30	750	0.012	0.3	9.41	239			
ELU14-1000	ELU16-1000	0.28	7	39	1000	0.012	0.3	12.52	318			

Part Code as per Stainless Steel Grade		Width		Length		Thickness		Max. Loop Diameter		Max Loop Tensile Strength		Package Quantity
SS304	SS316L	Inch	mm	Inch	mm	Inch	mm	Inch	mm	N	lbs	Pcs
ELU24-100	ELU26-100	0.47	12	4	100	0.012	0.3	0.94	24	800	180	100/bag
ELU24-150	ELU26-150			6	150	0.012	0.3	1.89	48			
ELU24-200	ELU26-200			8	200	0.012	0.3	2.52	64			
ELU24-225	ELU26-225			9	225	0.012	0.3	2.83	72			
ELU24-250	ELU26-250			10	250	0.012	0.3	3.15	80			
ELU24-300	ELU26-300			12	300	0.012	0.3	3.78	96			
ELU24-350	ELU26-350			14	350	0.012	0.3	4.33	110			
ELU24-360	ELU26-360			14	360	0.012	0.3	4.53	115			
ELU24-400	ELU26-400			16	400	0.012	0.3	5.28	134			
ELU24-450	ELU26-450			18	450	0.012	0.3	5.63	143			
ELU24-500	ELU26-500			20	500	0.012	0.3	6.54	166			
ELU24-550	ELU26-550			22	550	0.012	0.3	7.13	181			
ELU24-610	ELU26-610			24	610	0.012	0.3	7.64	194			
ELU24-750	ELU26-750			30	750	0.012	0.3	9.41	239			
ELU24-1000	ELU26-1000			39	1000	0.012	0.3	12.52	318			



LADDER TYPE CABLE TIES

COATED

Technical Specifications

- Material** : 304 and 316L grade non-magnetic stainless steel
- Temperature Range** : -60°C to +150°C
- Surface Finish** : Pure Polyester Coating
- Flamability Rating** : UL94 Fireproof & UV Resistant

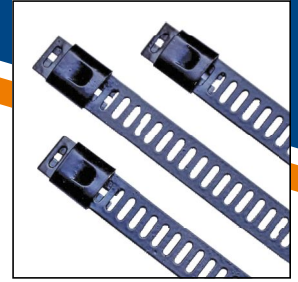

Part Code as per Stainless Steel Grade		Width		Length		Thickness		Max. Loop Diameter		Max Loop Tensile Strength		Package Quantity
SS304	SS316L	Inch	mm	Inch	mm	Inch	mm	Inch	mm	N	lbs	Pcs
ELC14-100	ELC16-100	0.28	7	4	100	0.012	0.3	0.94	24	400	90	100/bag
ELC14-150	ELC16-150	0.28	7	6	150	0.012	0.3	1.89	48			
ELC14-200	ELC16-200	0.28	7	8	200	0.012	0.3	2.52	64			
ELC14-225	ELC16-225	0.28	7	9	225	0.012	0.3	2.83	72			
ELC14-250	ELC16-250	0.28	7	10	250	0.012	0.3	3.15	80			
ELC14-300	ELC16-300	0.28	7	12	300	0.012	0.3	3.78	96			
ELC14-350	ELC16-350	0.28	7	14	350	0.012	0.3	4.33	110			
ELC14-360	ELC16-360	0.28	7	14	360	0.012	0.3	4.53	115			
ELC14-400	ELC16-400	0.28	7	16	400	0.012	0.3	5.28	134			
ELC14-450	ELC16-450	0.28	7	18	450	0.012	0.3	5.63	143			
ELC14-500	ELC16-500	0.28	7	20	500	0.012	0.3	6.54	166			
ELC14-550	ELC16-550	0.28	7	22	550	0.012	0.3	7.13	181			
ELC14-610	ELC16-610	0.28	7	24	610	0.012	0.3	7.64	194			
ELC14-750	ELC16-750	0.28	7	30	750	0.012	0.3	9.41	239			
ELC14-1000	ELC16-1000	0.28	7	39	1000	0.012	0.3	12.52	318			

Part Code as per Stainless Steel Grade		Width		Length		Thickness		Max. Loop Diameter		Max Loop Tensile Strength		Package Quantity
SS304	SS316L	Inch	mm	Inch	mm	Inch	mm	Inch	mm	N	lbs	Pcs
ELC24-100	ELC26-100	0.47	12	4	100	0.012	0.3	0.94	24	800	180	100/bag
ELC24-150	ELC26-150	0.47	12	6	150	0.012	0.3	1.89	48			
ELC24-200	ELC26-200	0.47	12	8	200	0.012	0.3	2.52	64			
ELC24-225	ELC26-225	0.47	12	9	225	0.012	0.3	2.83	72			
ELC24-250	ELC26-250	0.47	12	10	250	0.012	0.3	3.15	80			
ELC24-300	ELC26-300	0.47	12	12	300	0.012	0.3	3.78	96			
ELC24-350	ELC26-350	0.47	12	14	350	0.012	0.3	4.33	110			
ELC24-360	ELC26-360	0.47	12	14	360	0.012	0.3	4.53	115			
ELC24-400	ELC26-400	0.47	12	16	400	0.012	0.3	5.28	134			
ELC24-450	ELC26-450	0.47	12	18	450	0.012	0.3	5.63	143			
ELC24-500	ELC26-500	0.47	12	20	500	0.012	0.3	6.54	166			
ELC24-550	ELC26-550	0.47	12	22	550	0.012	0.3	7.13	181			
ELC24-610	ELC26-610	0.47	12	24	610	0.012	0.3	7.64	194			
ELC24-750	ELC26-750	0.47	12	30	750	0.012	0.3	9.41	239			
ELC24-1000	ELC26-1000	0.47	12	39	1000	0.012	0.3	12.52	318			



CABLE MARKER TAGS & CARRIER STRIPS

Technical Specifications

- Material** : 316L grade non-magnetic stainless steel
- Temperature Range** : -60°C to +300°C
- Surface Finish** : Metallic & Epoxy / Polyester Coating (Carrier Strip)
- Flamability Rating** : UL94 Fireproof & UV Resistant

Part Code	Width		Length		Thickness		Package Quantity	Product Design
	Inch	mm	Inch	mm	Inch	mm		
SS316							Pcs	
ET7407/0.50	2/7	7	3	74	0.02	0.5	100/BAG	
ET8909/0.50	3/8	9.5	3 1/2	89	0.02	0.5		
ET8909/0.30	3/8	9.5	3 1/2	89	0.01	0.3		
ET8919/0.50	3/4	19	3 1/2	89	0.02	0.5		
ET8919/0.25	3/4	19	3 1/2	89	0.01	0.25		
ETS8919/0.50	3/4	19	3 1/2	89	0.02	0.5		
ETCP8919/0.50	3/4	19	3 1/2	89	0.02	0.5		
ET6338/0.50	1 1/2	38	2 1/2	63	0.02	0.5		

Part Code		Width		Length		Thickness		Package Quantity
Uncoated	Coated	Inch	mm	Inch	mm	Inch	mm	Pcs
ENID 6	ENIDC 6	1/3	8	3 2/3	92.5	0.02	0.5	100/BAG
ENID 10	ENIDC 10	1/3	8	5 1/7	132.5	0.02	0.5	
ENID 12	ENIDC 12	1/3	8	6	152.5	0.02	0.5	
ENID 16	ENIDC 16	1/3	8	7 2/5	192.5	0.02	0.5	
ENID 22	ENIDC 22	1/3	8	10	252.5	0.02	0.5	

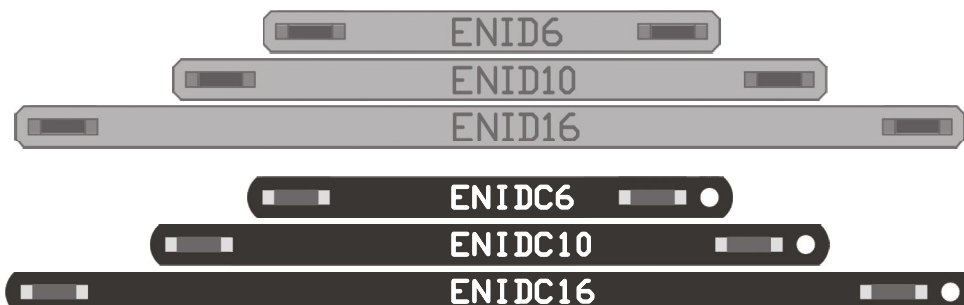



STRAPS

Technical Specifications

Material	: SS 201, SS 304 & SS 316
Temperature Range	: -60°C to +300°C (Uncoated) -60°C to +150°C (Coated)
Surface Finish	: Coated / Uncoated
Flamability Rating	: UL94 Fireproof & UV Resistant

Part Code as per Stainless Steel Grade			Width		Thickness		Finished Length		Average Breaking Strength						Package Quantity
SS201	SS304	SS316	Inch	mm	Inch	mm	feet	Mtrs	SS201		SS304		SS316		Pcs
									N	lbs	N	lbs	N	lbs	
ESU1-1X30	ESU4-1X30	ESU6-1X30	1/4	6.5	0.02	0.5	100	30.5	2225	500	1669	375	1780	400	100' / Roll
ESU1-2Y30	ESU4-2Y30	ESU6-2Y30	3/8	9.5	0.026	0.65	100	30.5	4005	900	3115	700	3338	750	100' / Roll
ESU1-3Z30	ESU4-3Z30	ESU6-3Z30	1/2	12.7	0.03	0.75	100	30.5	6675	1500	4895	1100	5340	1200	100' / Roll
ESU1-4Z30	ESU4-4Z30	ESU6-4Z30	5/8	16	0.03	0.75	100	30.5	8345	1875	6230	1400	6675	1500	100' / Roll
ESU1-5Z30	ESU4-5Z30	ESU6-5Z30	3/4	19	0.03	0.75	100	30.5	10015	2250	7365	1700	8010	1800	100' / Roll
-	ESP4-1X30	ESP6-1X30	1/4	6.5	0.02	0.5	100	30.5	-	-	1490	335	1490	335	100' / Roll
-	ESP4-2Y30	ESP6-2Y30	3/8	9.5	0.026	0.65	100	30.5	-	-	2250	505	2250	505	100' / Roll
-	ESP4-3Z30	ESP6-3Z30	1/2	12.7	0.03	0.75	100	30.5	-	-	2980	670	2980	670	100' / Roll
-	ESP4-4Z30	ESP6-4Z30	5/8	16	0.03	0.75	100	30.5	-	-	3740	840	3740	840	100' / Roll
-	ESP4-5Z30	ESP6-5Z30	3/4	19	0.03	0.75	100	30.5	-	-	4450	1000	4450	1000	100' / Roll

NOMENCLATURE

PRODUCT TYPE: ES/EA

SURFACE FINISH: U/C/P

MATERIAL GRADE: 1/4/6/G

WIDTH: 1/2/3/4/5

THICKNESS: X/Y/Z

STRAP LENGTH: xx

ES: STRAP
EA: ALL PURPOSE BANDS

U: UNCOATED
C: EPOXY/POLYESTER COATED
P: PPA 571 COATED

1: SS 201 / 4: SS 304
6: SS 316 / G: GCS

1: 6.5mm / 2: 9.5mm
3: 12.7mm / 4: 16mm / 5: 19mm

X: 0.50mm / Y: 0.65mm
Z: 0.75mm

xx: 3, 10, 25, 30.5, 50, 61



ALL PURPOSE BANDS

Technical Specifications

Material	: SS 304, SS 316 & Galvanised Carbon Steel (GCS)
Temperature Range	: -60°C to +300°C (Uncoated) -60°C to +150°C (Coated)
Surface Finish	: Coated / Uncoated
Flamability Rating	: UL94 Fireproof & UV Resistant



UNCOATED

Part Code as per Stainless Steel Grade			Width		Thickness		Finished Length		Diameter of Hole		Package Quantity
GCS	SS304	SS316	Inch	mm	Inch	mm	feet	Mtrs	Inch	mm	Pcs
EAUG-3Z03	EAU4-3Z03	EAU6-3Z03	1/2	12.7	0.03	0.75	9.9	3	3/16	5	9.9' / Roll
EAUG-3Z10	EAU4-3Z10	EAU6-3Z10	1/2	12.7	0.03	0.75	33	10	3/16	5	33' / Roll
EAUG-3Z25	EAU4-3Z25	EAU6-3Z25	1/2	12.7	0.03	0.75	82.5	25	3/16	5	82.5' / Roll
EAUG-5Z03	EAU4-5Z03	EAU6-5Z03	3/4	19	0.03	0.75	9.9	3	9/32	7	9.9' / Roll
EAUG-5Z10	EAU4-5Z10	EAU6-5Z10	3/4	19	0.03	0.75	33	10	9/32	7	33' / Roll
EAUG-5Z25	EAU4-5Z25	EAU6-5Z25	3/4	19	0.03	0.75	82.5	25	9/32	7	82.5' / Roll



PPA 571 COATED

Part Code as per Stainless Steel Grade			Width		Thickness		Finished Length		Diameter of Hole		Package Quantity
GCS	SS304	SS316	Inch	mm	Inch	mm	feet	Mtrs	Inch	mm	Pcs
EAPG-3Z03	EAP4-3Z03	EAP6-3Z03	1/2	12.7	0.03	0.75	9.9	3	3/16	5	9.9' / Roll
EAPG-3Z10	EAP4-3Z10	EAP6-3Z10	1/2	12.7	0.03	0.75	33	10	3/16	5	33' / Roll
EAPG-3Z25	EAP4-3Z25	EAP6-3Z25	1/2	12.7	0.03	0.75	82.5	25	3/16	5	82.5' / Roll
EAPG-5Z03	EAP4-5Z03	EAP6-5Z03	3/4	19	0.03	0.75	9.9	3	9/32	7	9.9' / Roll
EAPG-5Z10	EAP4-5Z10	EAP6-5Z10	3/4	19	0.03	0.75	33	10	9/32	7	33' / Roll
EAPG-5Z25	EAP4-5Z25	EAP6-5Z25	3/4	19	0.03	0.75	82.5	25	9/32	7	82.5' / Roll

BUCKLES



Technical Specifications

- Material** : SS 201, SS 304 & SS 316
Temperature Range : -60°C to +300°C (Uncoated)
 : -60°C to +150°C (Coated)
Surface Finish : Coated / Uncoated
Flamability Rating : UL94 Fireproof & UV Resistant

Part Code as per Stainless Steel Grade			Width		Package Quantity
SS201	SS304	SS316	Inch	mm	Pcs
EJU1-06	EJU4-06	EJU6-06	1/4	6.5	100/BAG
EJU1-09	EJU4-09	EJU6-09	3/8	9.5	100/BAG
EJU1-12	EJU4-12	EJU6-12	1/2	12.7	100/BAG
EJU1-16	EJU4-16	EJU6-16	5/8	16	100/BAG
EJU1-19	EJU4-19	EJU6-19	3/4	19	100/BAG

Part Code as per Stainless Steel Grade			Width		Package Quantity
SS201	SS304	SS316	Inch	mm	Pcs
EJC1-06	EJC4-06	EJC6-06	1/4	6.5	100/BAG
EJC1-09	EJC4-09	EJC6-09	3/8	9.5	100/BAG
EJC1-12	EJC4-12	EJC6-12	1/2	12.7	100/BAG
EJC1-16	EJC4-16	EJC6-16	5/8	16	100/BAG
EJC1-19	EJC4-19	EJC6-19	3/4	19	100/BAG

Part Code as per Stainless Steel Grade			Width		Package Quantity
SS201	SS304	SS316	Inch	mm	Pcs
EWU1-06	EWU4-06	EWU6-06	1/4	6.5	100/BAG
EWU1-09	EWU4-09	EWU6-09	3/8	9.5	100/BAG
EWU1-12	EWU4-12	EWU6-12	1/2	12.7	100/BAG
EWU1-16	EWU4-16	EWU6-16	5/8	16	100/BAG
EWU1-19	EWU4-19	EWU6-19	3/4	19	100/BAG

Part Code as per Stainless Steel Grade			Width		Package Quantity
SS201	SS304	SS316	Inch	mm	Pcs
EWC1-06	EWC4-06	EWC6-06	1/4	6.5	100/BAG
EWC1-09	EWC4-09	EWC6-09	3/8	9.5	100/BAG
EWC1-12	EWC4-12	EWC6-12	1/2	12.7	100/BAG
EWC1-16	EWC4-16	EWC6-16	5/8	16	100/BAG
EWC1-19	EWC4-19	EWC6-19	3/4	19	100/BAG





TOOLS



1. EN - AG 01 CABLE TIE TENSIONING AND CUTTING AUTOMATIC GUN



2. EN - HP 02 CABLE TENSIONING AND CUTTING HAND PLIER

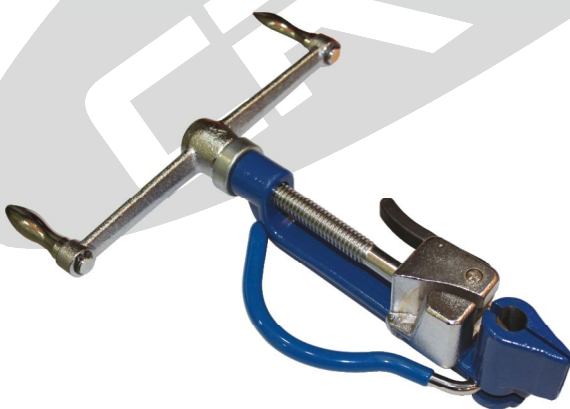

3. EN - BS 03 BAND STRAP TENSIONING AND CUTTING TOOL

CORPORATE OFFICE & WORKS

"Crystal House",

**Building No. 4, Behind Blue Berry Industrial Estate,
Opp. Meenakshi Industrial Estate-1, Naik Pada,
Waliv Village, Vasai Road (East),
Dist. Palghar - 401 208, Maharashtra (INDIA).**

Tel.: +91 - 9819862790 / +91- 7666995852 / +91 - 9920374775

Email: utsav@groupcrystal.com / info@groupcrystal.com

Website : www.groupcrystal.com